

M1D1:

Complete *in silico* cloning of protein expression plasmid

1. Laboratory Orientation quiz
2. Prelab discussion
3. Build protein expression plasmid - virtually
4. Confirm protein expression plasmid - actually

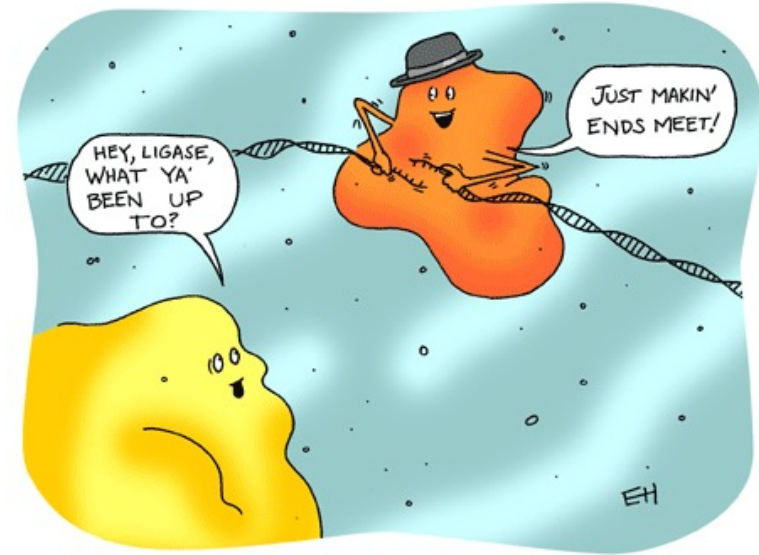

Mark your calendars!

- **Data summary** (15%)
 - completed in teams and submitted via Canvas
 - draft due 3/18, final revision due 3/27
- **Research talk** (5%)
 - completed individually and submitted via Gmail
 - due 3/4
- **Laboratory quizzes**
 - scheduled for M1D4 and M1D8
- **Notebook** (5% and part of 5% Participation score)
 - one entry submitted via Canvas 24 hr after M1D8
- **Blogpost** (part of 5% Participation score)
 - due 3/20 via Slack



Overview of Mod 1 experiments:

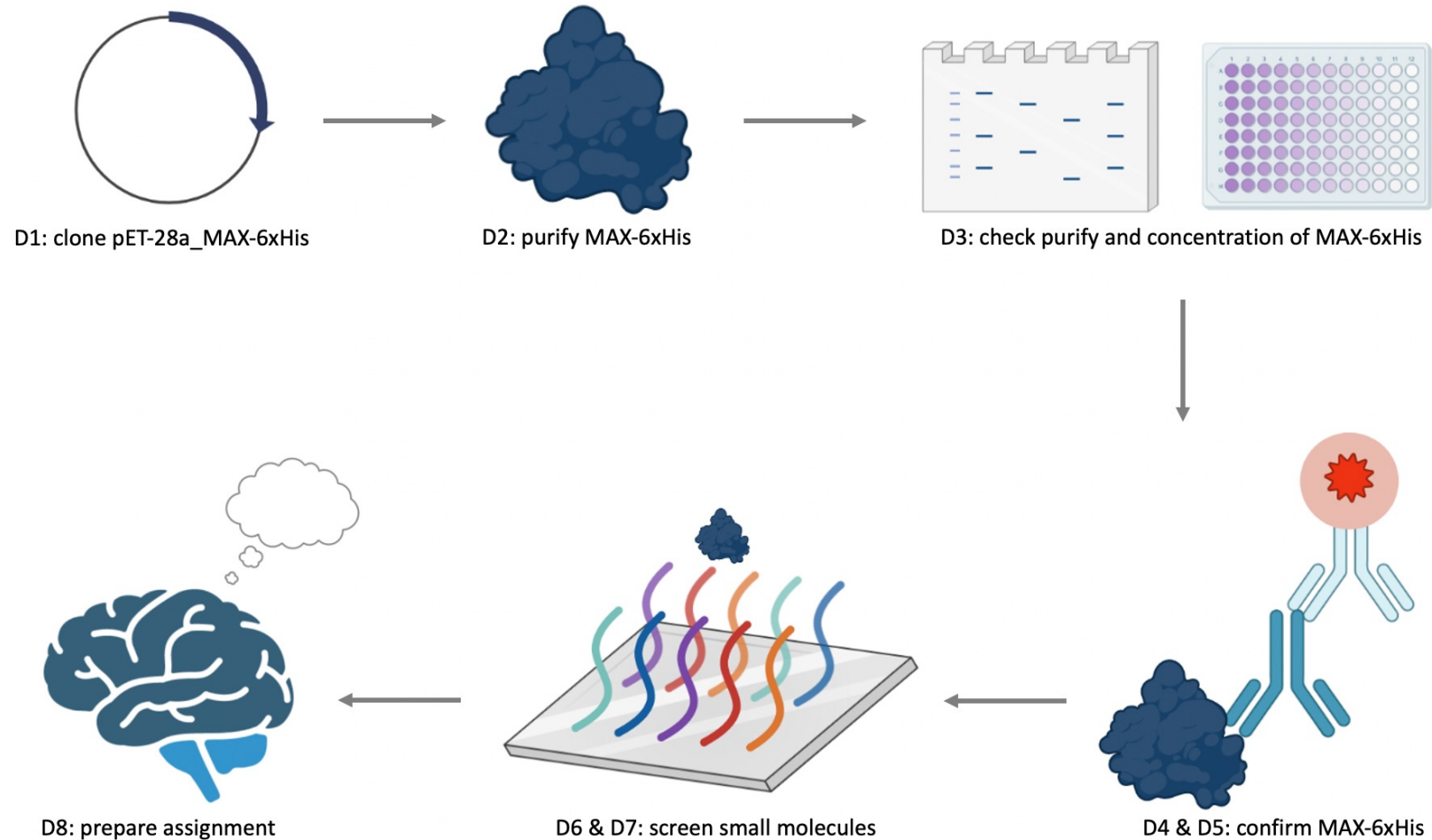

It all starts with DNA...

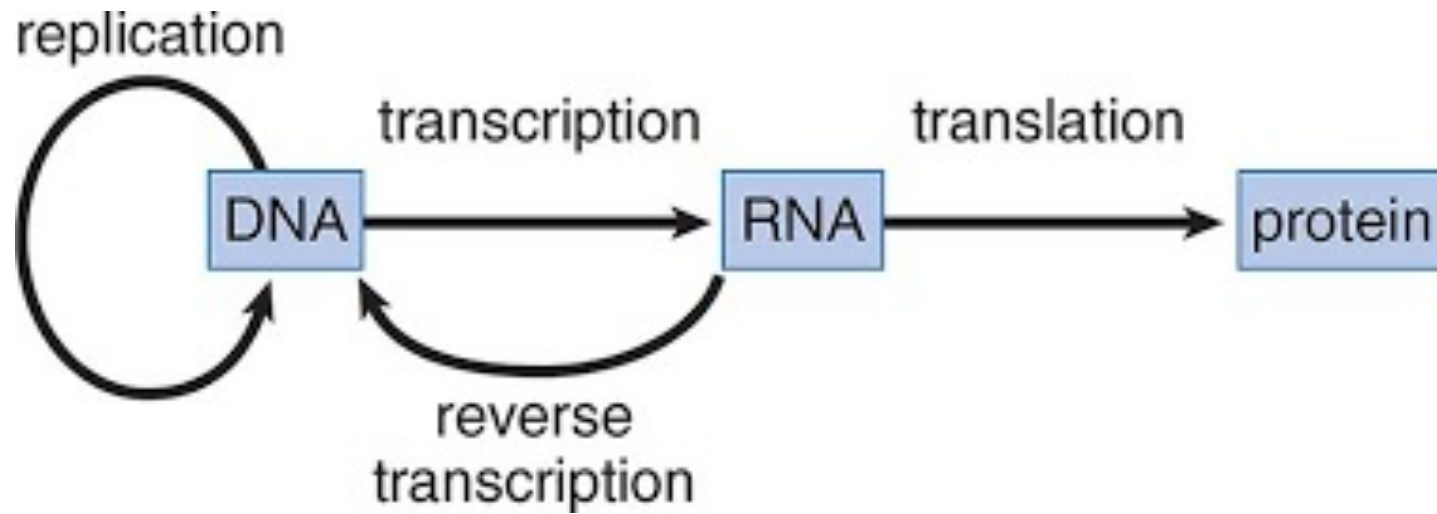

How do we engineer DNA?

1. Prepare insert
2. Digest insert and vector
3. Ligate insert into vector

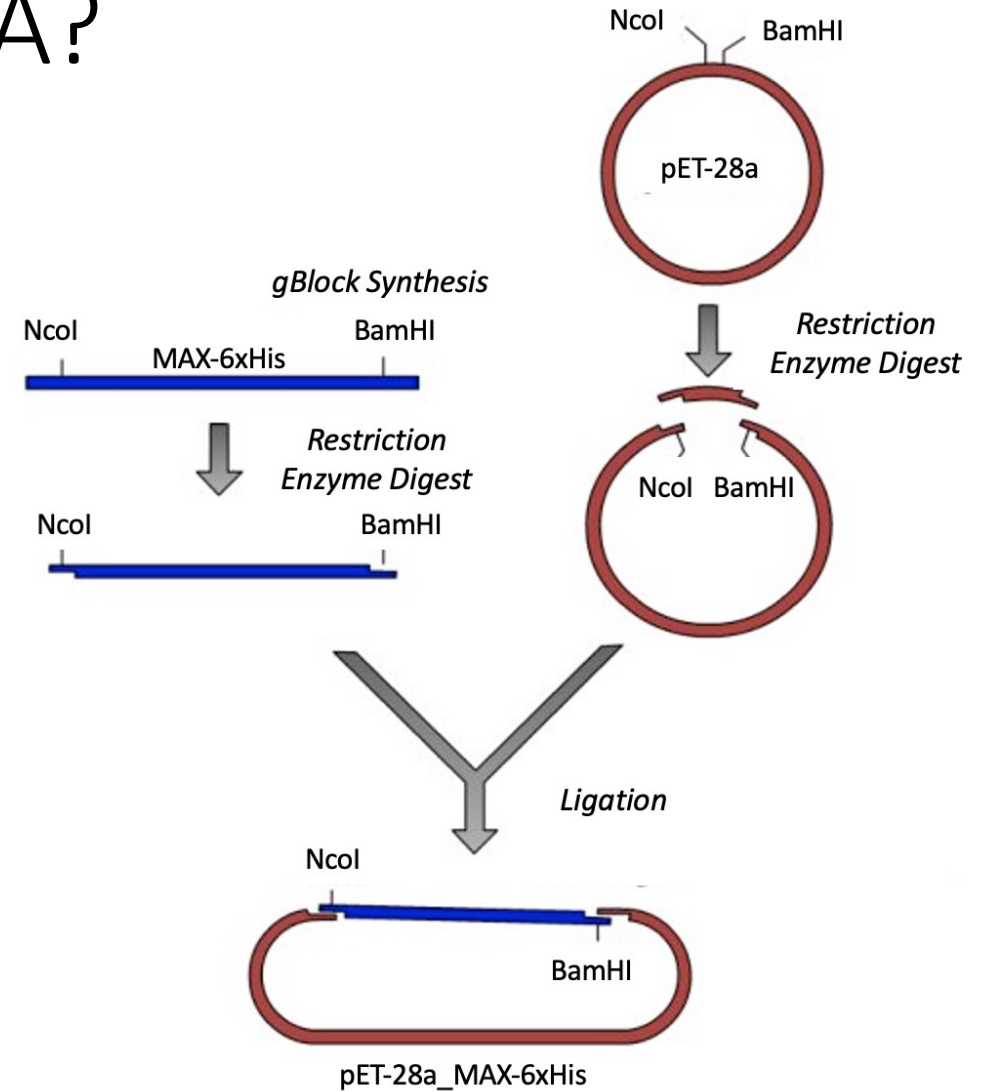

1. Prepare insert by designing gBlock



2. Digest insert and vector using restriction enzymes

Why are most restriction sites palindromes?

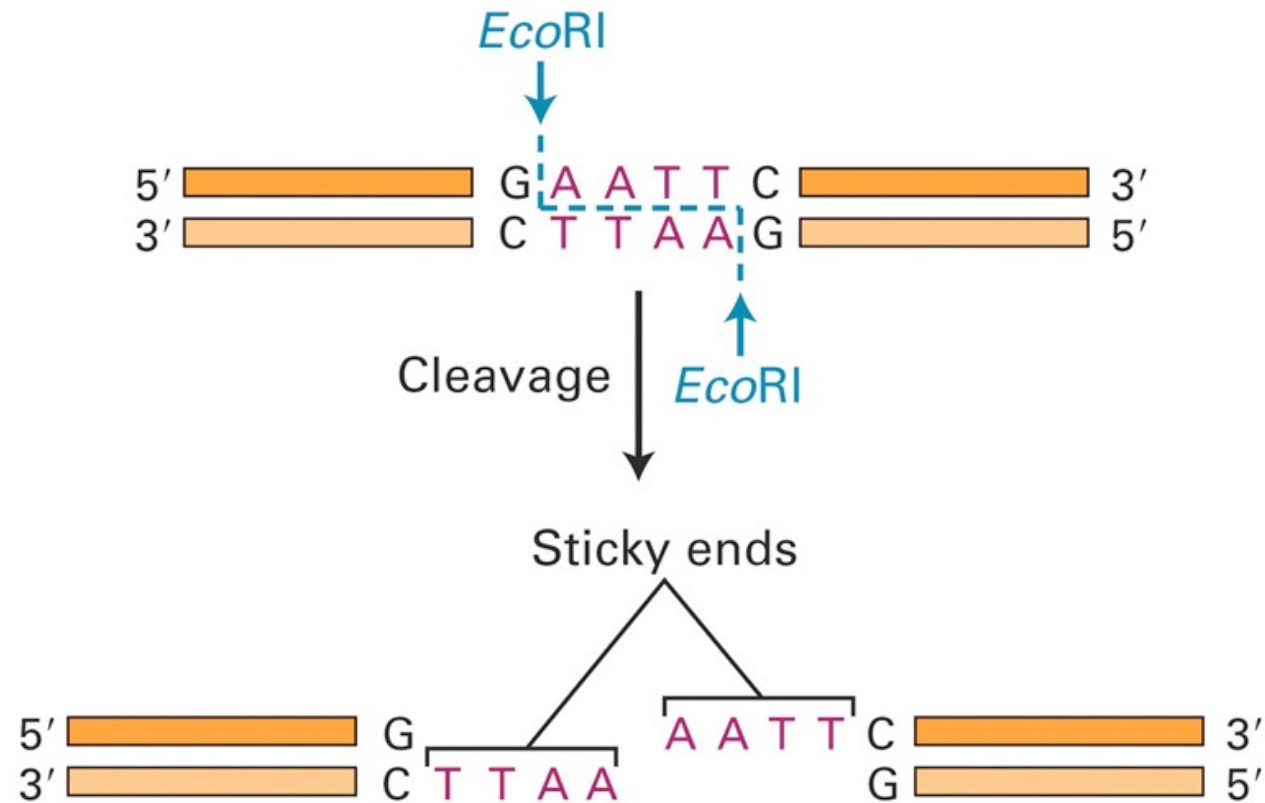

Restriction enzymes cleave DNA at specific sequences

Function as homodimers

- Each dimer cleaves backbone at site of palindromic recognition sequence

How do restriction enzymes recognize DNA sequences?

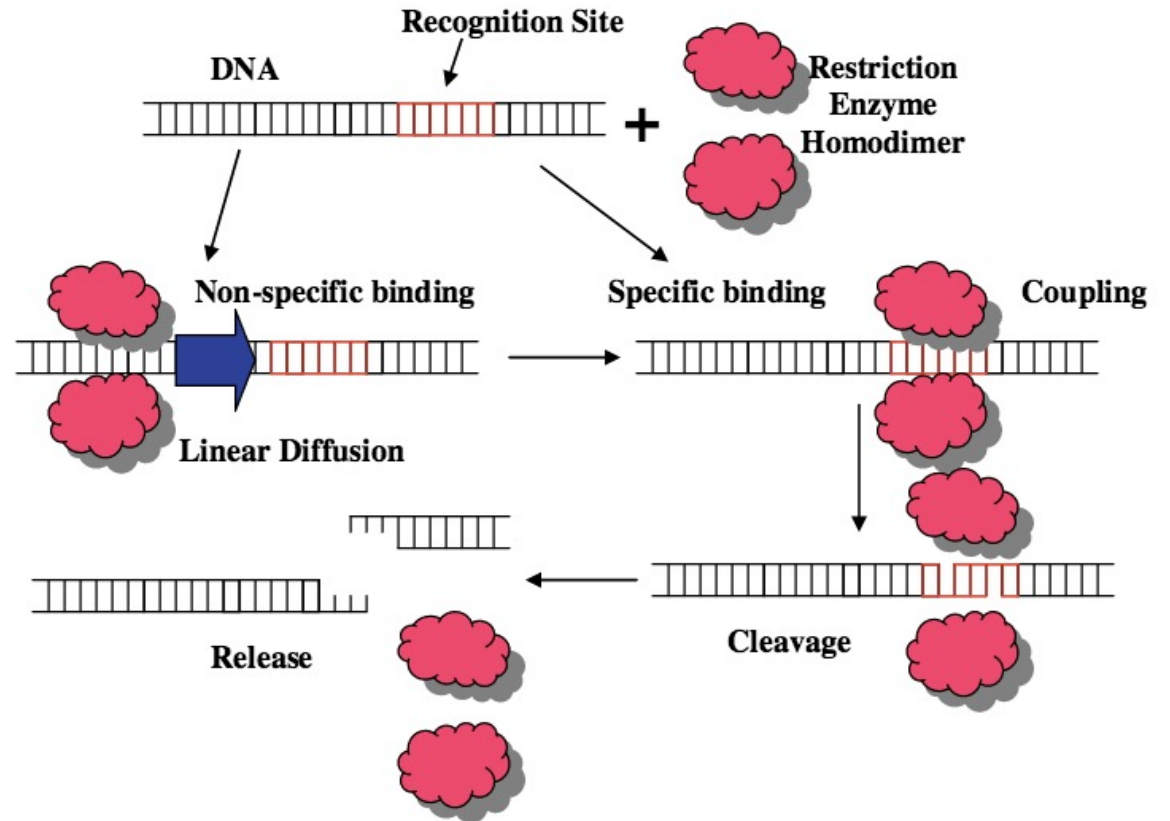

What are we digesting?

What should we consider when performing a double digest?

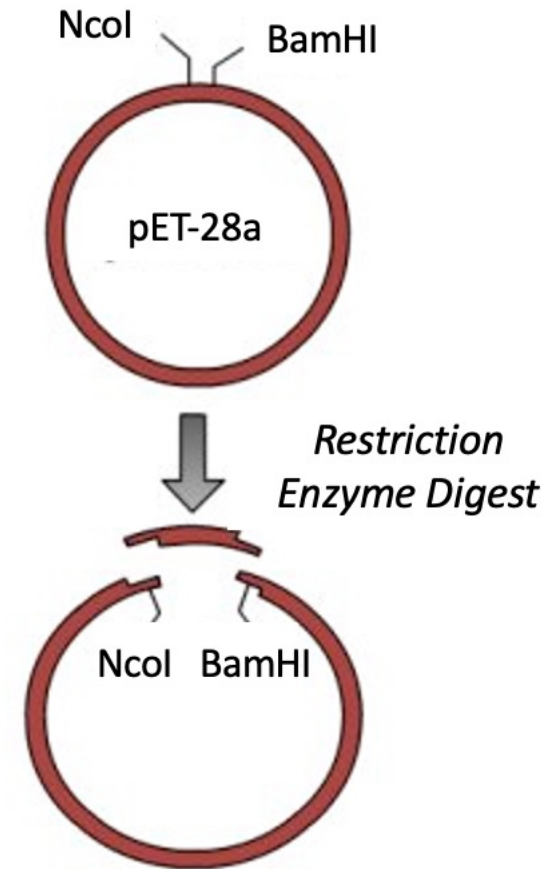
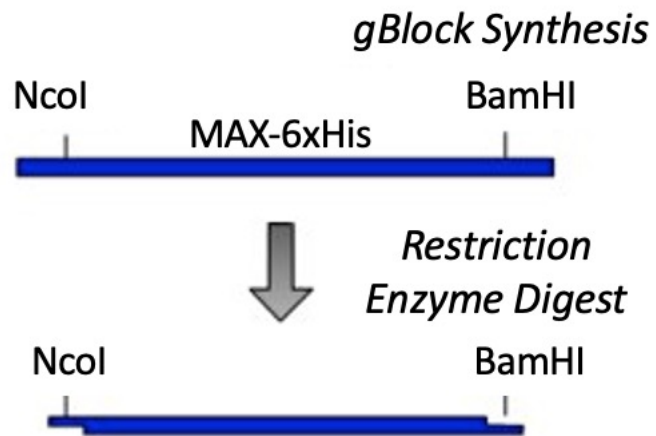

3. Ligate insert into vector using ligase enzyme

How are compatible DNA ends paired prior to ligation?

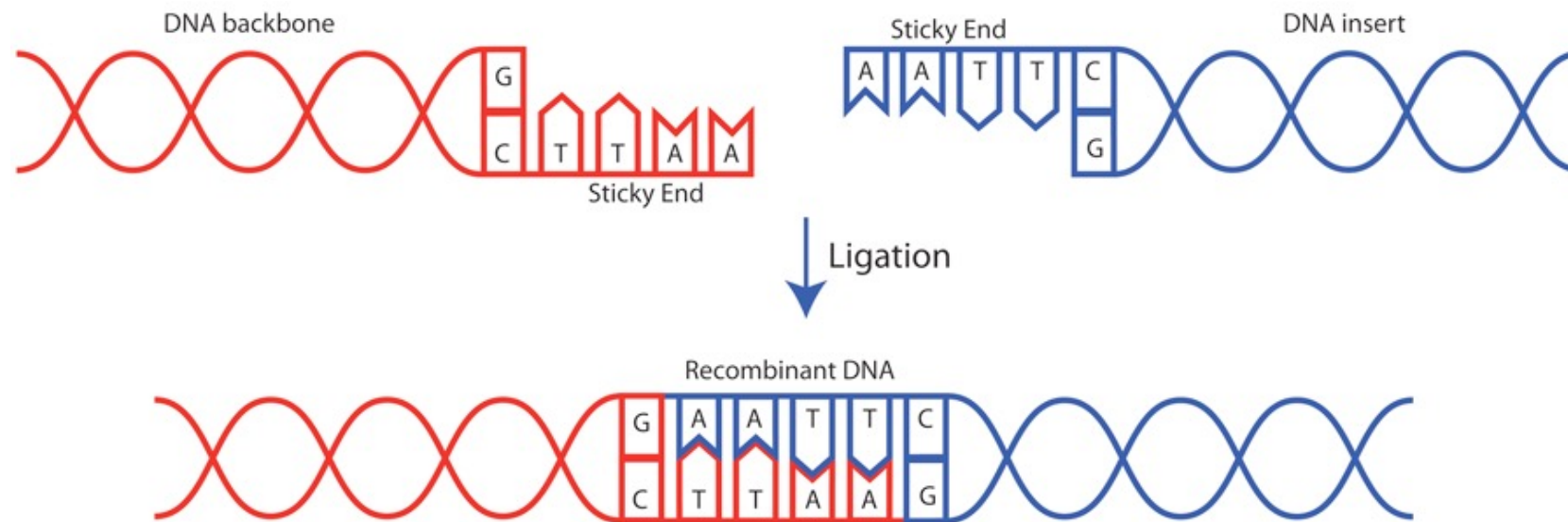

DNA ligase catalyzes formation of covalent phosphodiester bond

DNA ends from 3' OH acceptor and 5' phosphate donor joined

- Requires ATP for adenylation of lysine residue in active site of DNA ligase
- AMP then transferred to 5' phosphate of DNA base

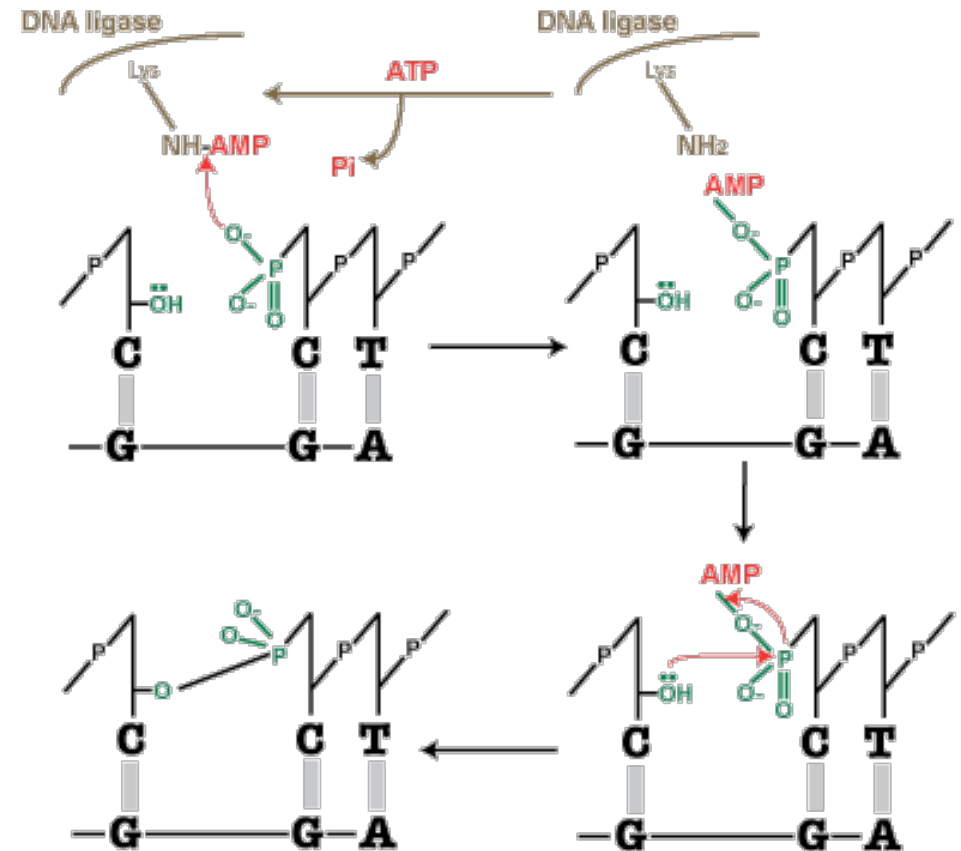

What are we ligating?

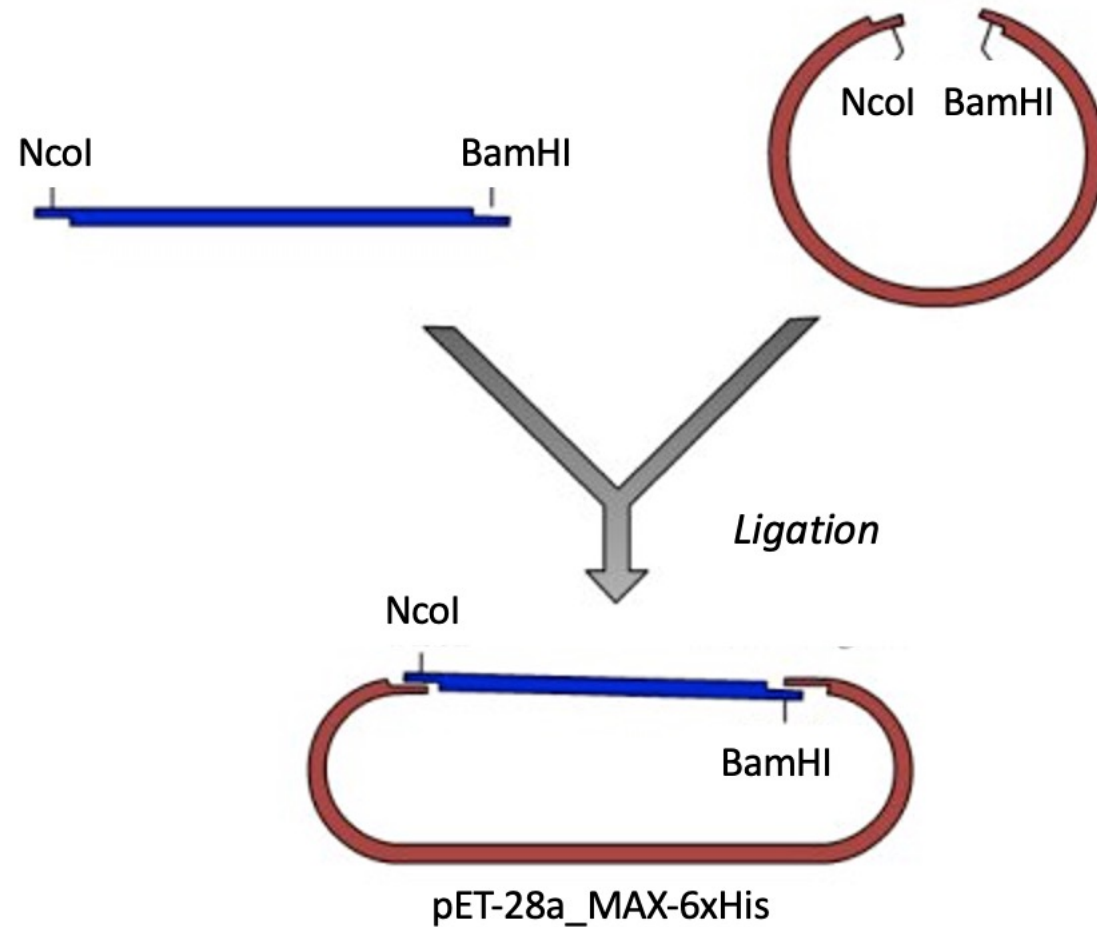

How are ligation reactions prepared?

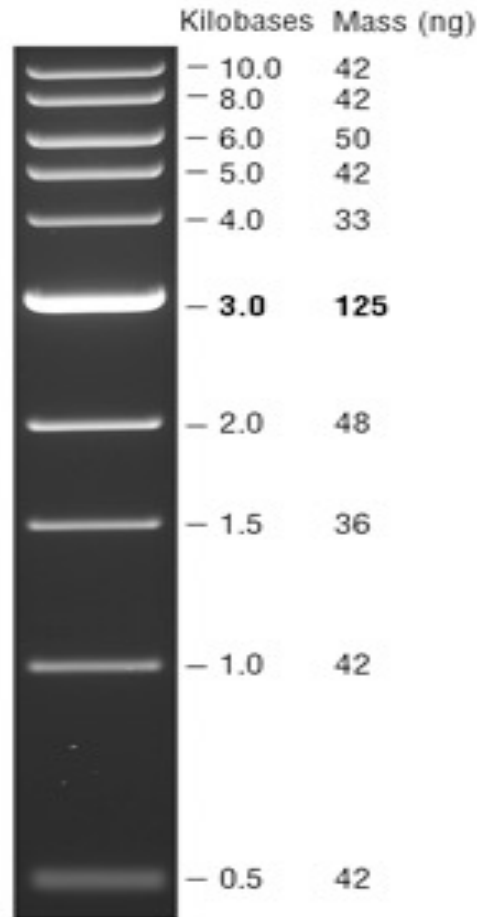
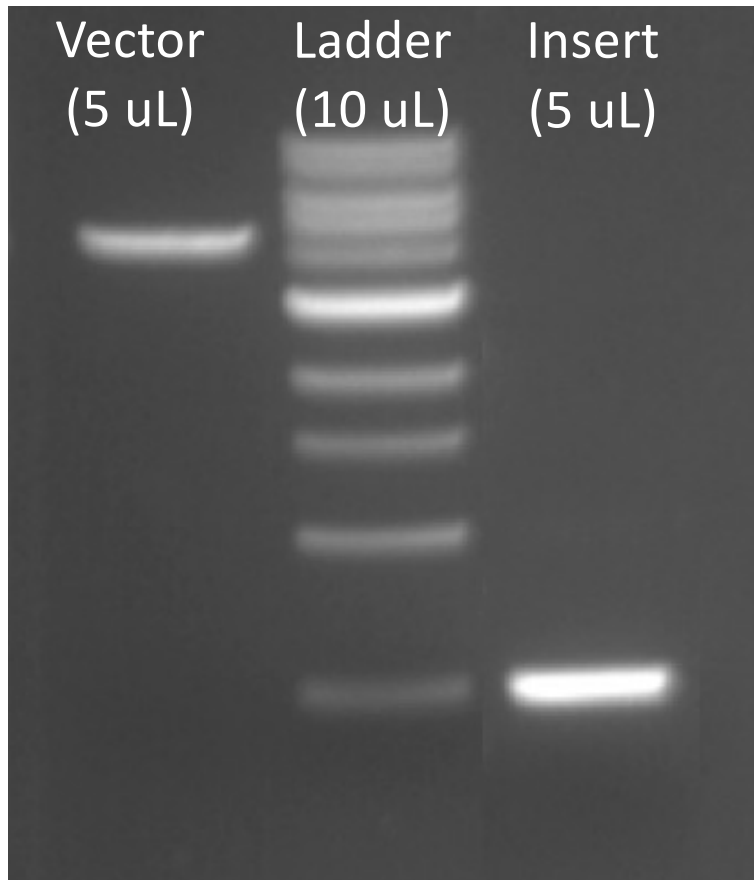

- Ideally, want 3:1 **molar** ratio of insert:backbone
- Calculate molar amounts from concentrations and sizes of DNA molecules

Ligation calculations

1. Determine volume of backbone
 - Use backbone concentration = [provided in exercise] ng/uL
 - Want 50 – 100 ng
2. Calculate moles of backbone
 - Vector = [determined during exercise] bp, MW bp = 660 g/mol
3. Calculate moles of insert
 - Insert = [determined during exercise] bp, 3:1 ratio of insert:backbone
4. Calculate volume of insert
 - Use insert concentration = [provided in exercise] ng/uL

How do we confirm cloning products?

Created by SnapGene

1. Transform plasmid into competent cells
2. Isolate plasmid from cultured cells
3. Digest plasmid using restriction enzymes

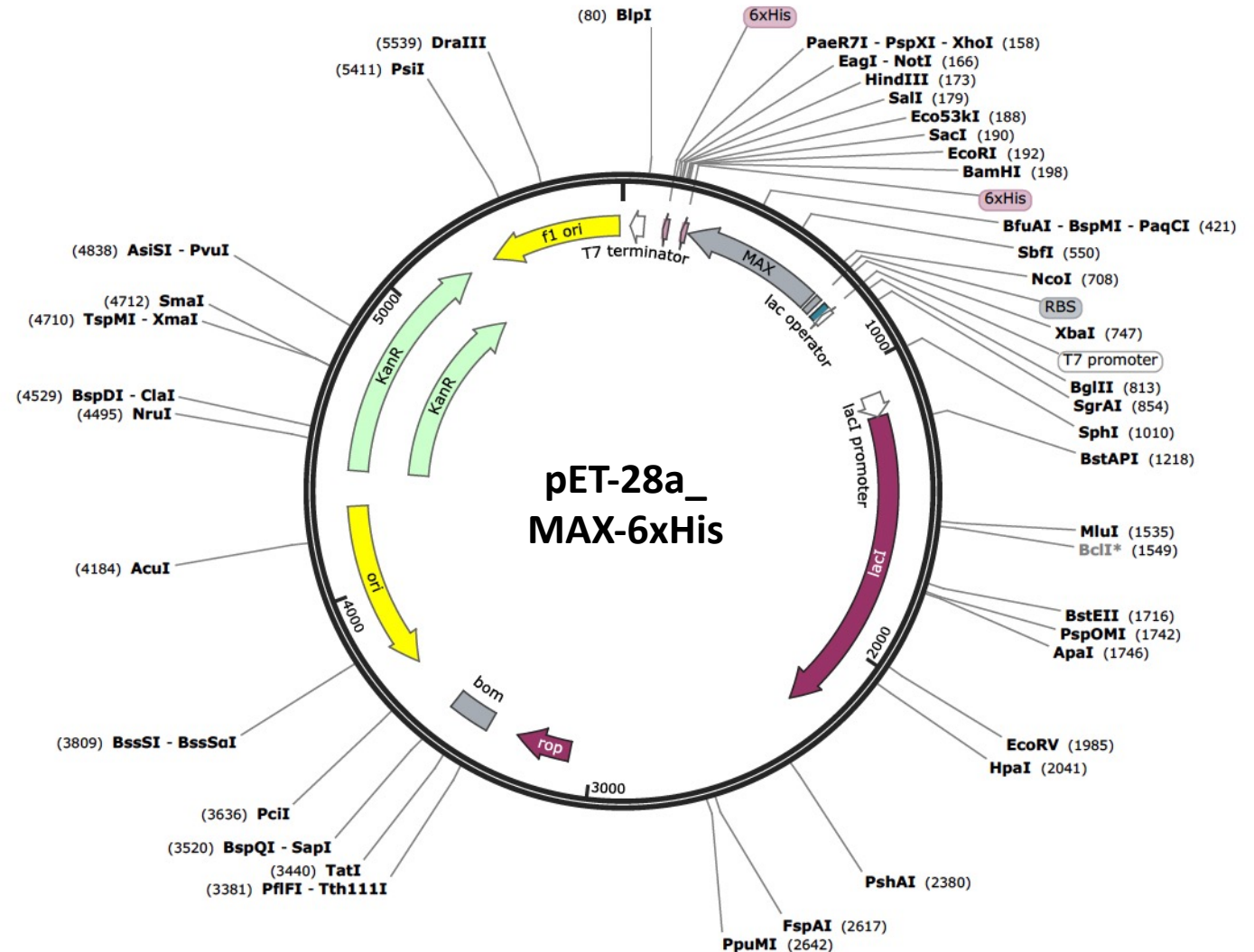

1. Transformation used to promote uptake of foreign DNA in bacteria

Why do we transform the ligation product?

1. Incubation
2. Heat shock
 - DNA taken in by competent cells
3. Recovery
4. Selection

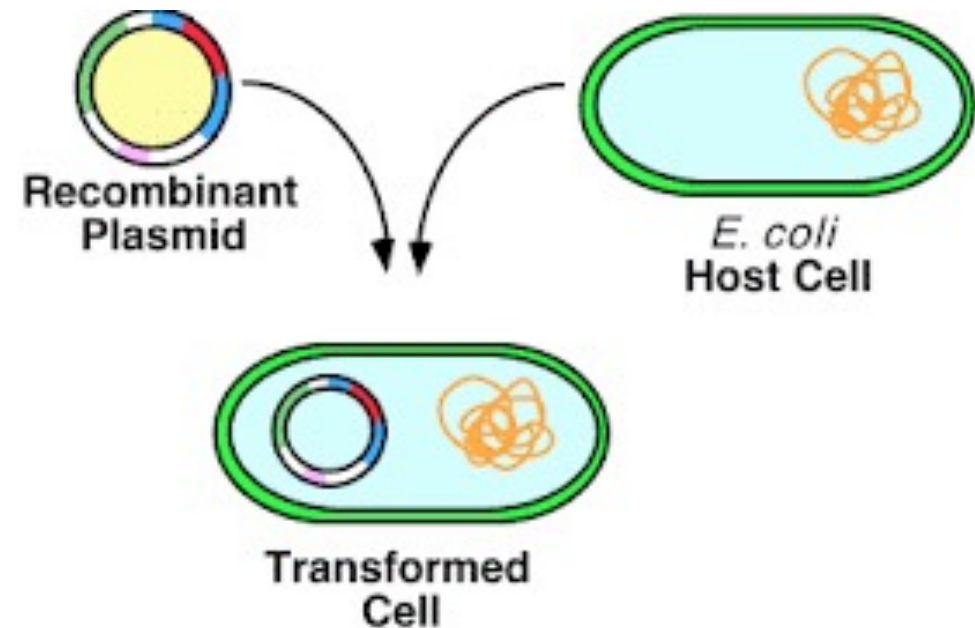

2. Purification used to isolate plasmid DNA

Why do we purify (mini-prep) the ligation product?

1. Resuspend cells
2. Lyse
3. Neutralize
 - Separates chromosomal DNA from plasmid DNA
4. Wash
5. Resuspend or elute DNA

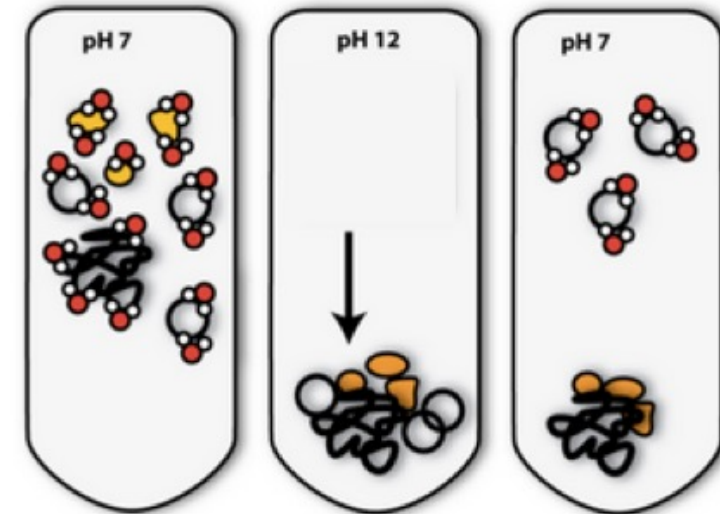
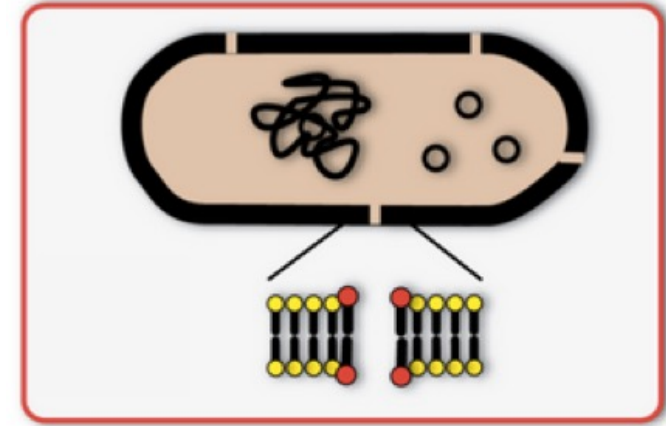

3. Digestion, another one

- Initially a digest is required to prepare components for cloning reaction
- Confirmation digest is used to confirm cloning success
 - Ideally, will cut once in insert and once in vector

Should we digest with XbaI and EcoRI? PstI? NcoI?

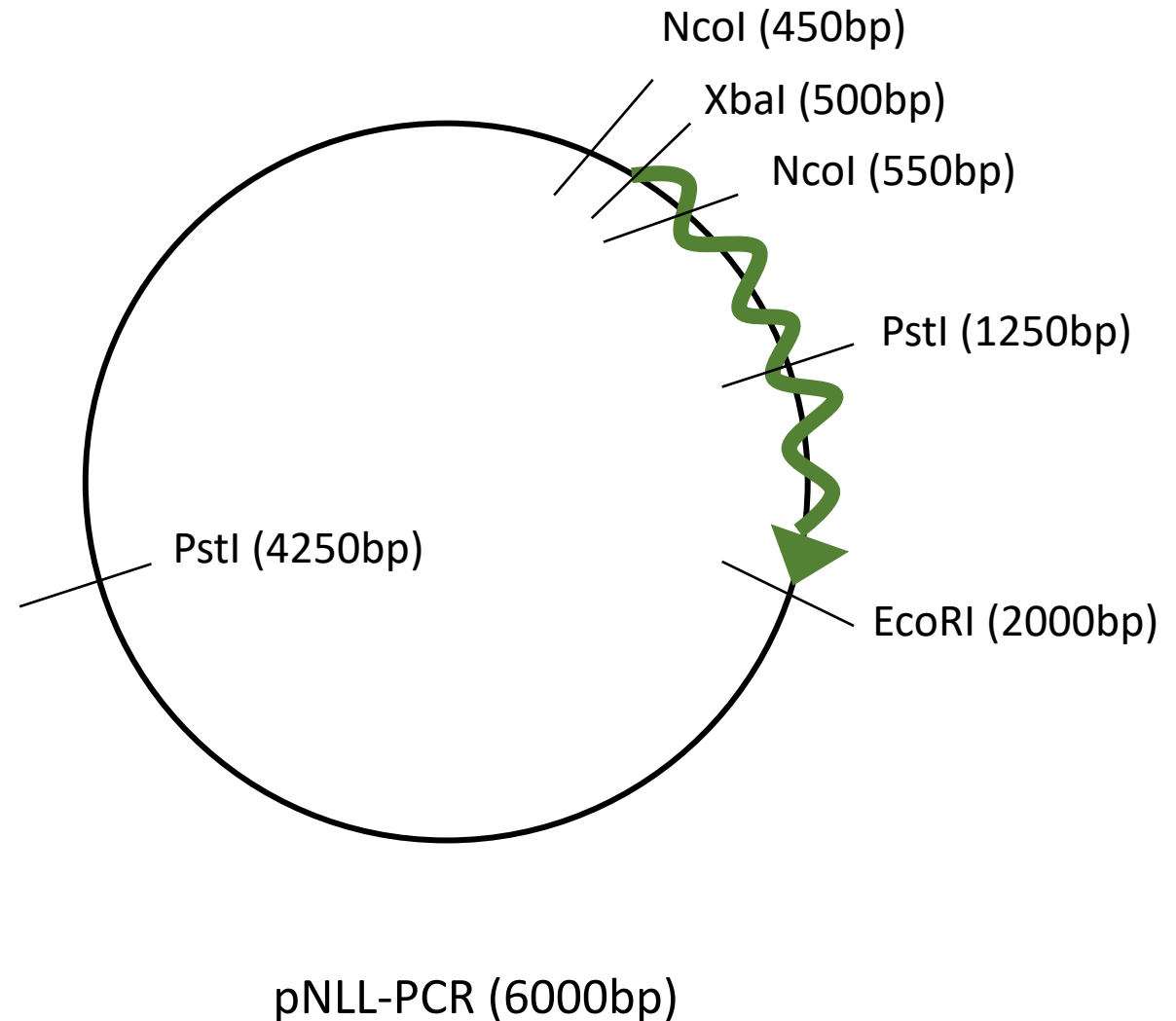

For today...

- Virtual cloning exercise to build pET-28a_MAX-6xHis expression plasmid
- Confirmation digest of pET-28a_MAX-6xHis

For M1D2...

- Answer prompts regarding M1 background information
- Complete in class exercises from M1D1