

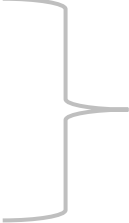
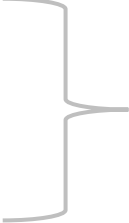
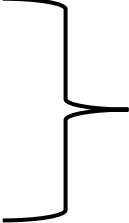
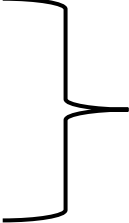

A cluster of blue lemons is centered on a light blue background. The lemons are rendered with a textured, slightly bumpy surface and are arranged in a loose, overlapping pile. A white rectangular box with a black border is superimposed over the center of the lemons, containing the main text.

Screening a system—laboratory approaches to
assessing features of a bioremediation system

Module Outline

- M2D1: Environmental heavy metal contamination  Intro
- M2D2: Model system – target selection and engineering approach 
- M2D3: Model system – choosing a chassis host  Design
- **M2D4: Screening a system—assessing features of a bioremediation system** 
- M2D5: Analysis of elemental metals – laboratory and field approaches  Test
- M2D6: Applying remediation strategies—advantages and pitfalls 
- M2D7: Engineering a problem-specific bioremediation solution  Apply
- M2D8: Comm Lab  Review

Lecture overview

3 key parameters of our bioremediation system should be established

- Is our mutant protein expressed?
- Does our mutant transporter show any differential ability to take up metal?
- Does our cell tolerate metal exposure and uptake?



Protein expression

Fet4_mutant expression can be established with immunofluorescence

- Antibodies against protein or incorporated tag
- Confirms that mutant protein is translated and trafficked as expected
- Automated 96 well microscopy for adherent cells

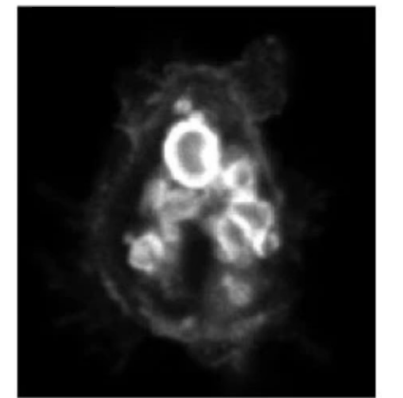
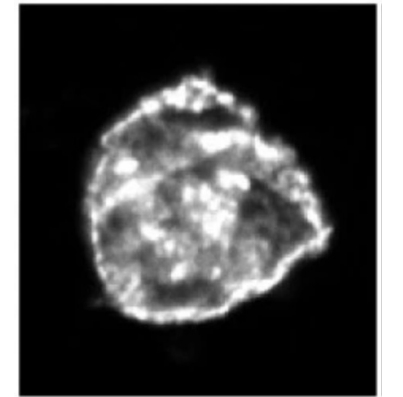
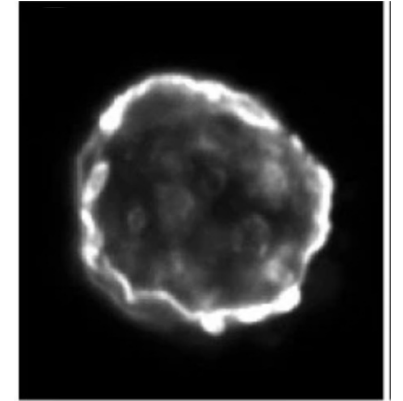
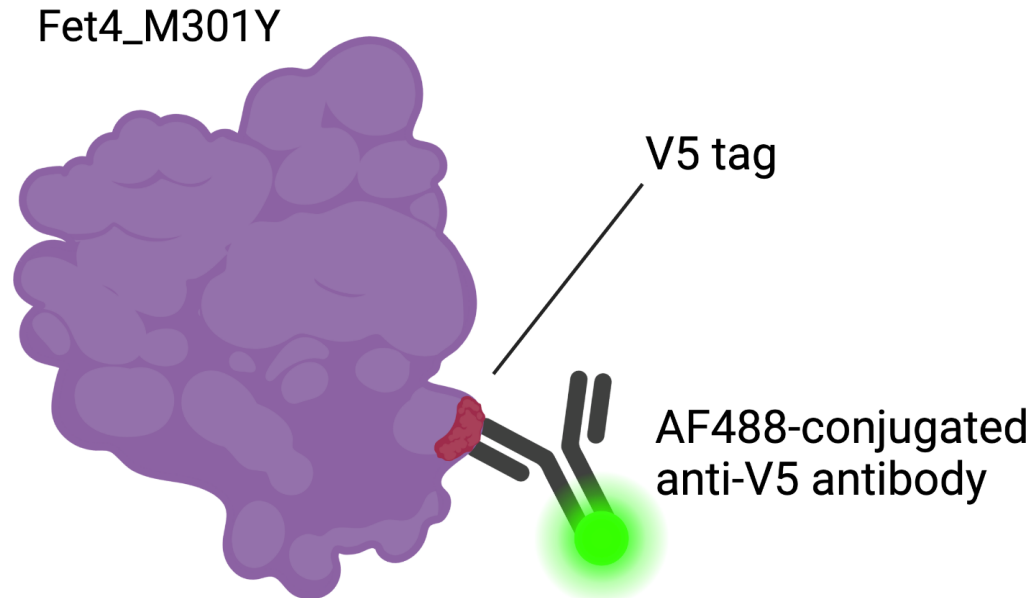

Flow cytometry can also be used to quantify protein expression

- Cells expressing mutant protein are labeled with fluorescent antibodies
- Labeled cells are passed in single file in front of a laser and visible light source
 - the scatter of the visible light provides information about cell size and granularity
 - fluorescent signal indicates protein labeling by antibody

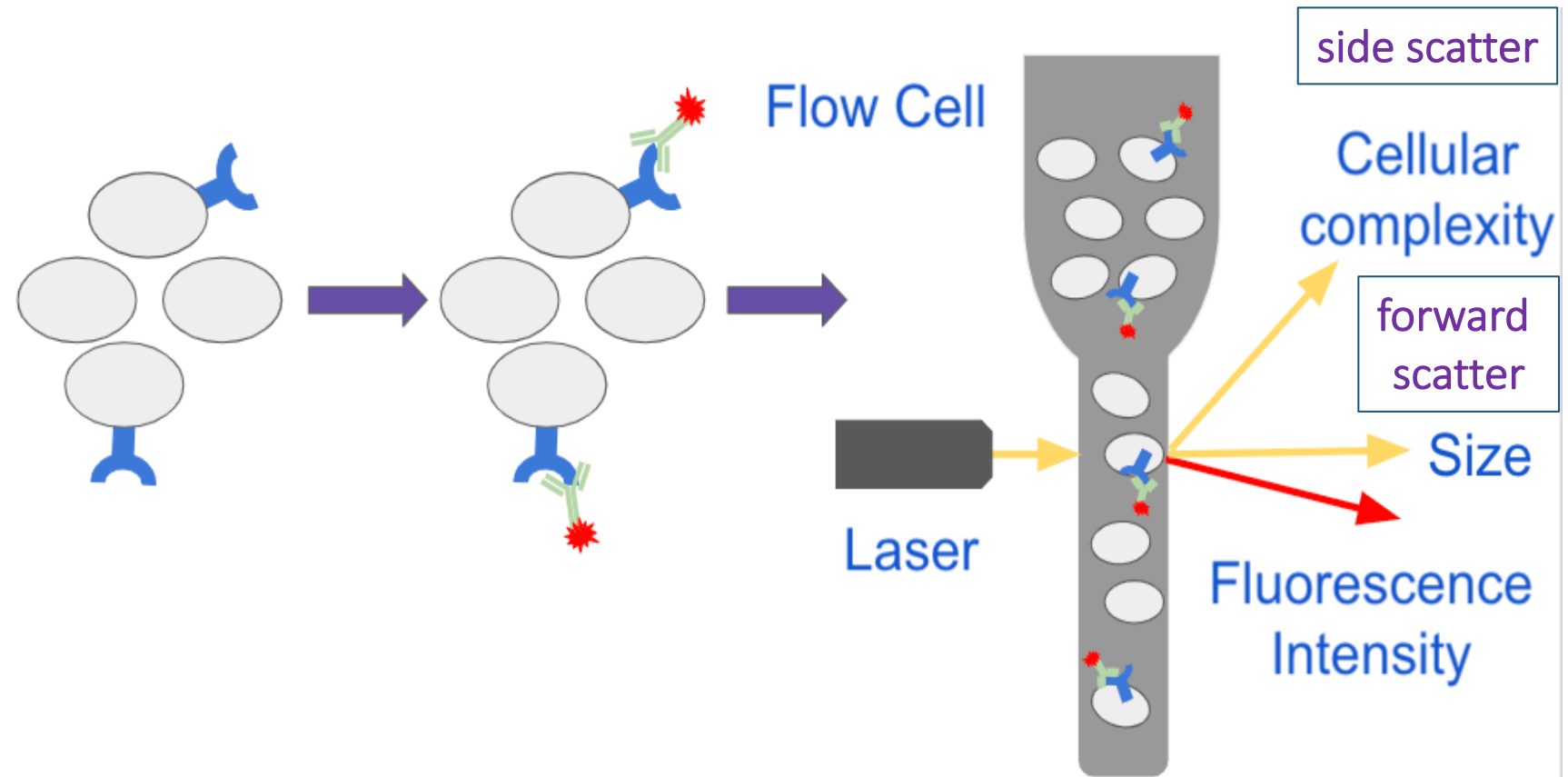

Metal uptake

ICP-OES/MS can measure elemental concentration in a sample

- Metal concentration can be quantified based on assessment of atomic properties
- Inductively Coupled Plasma Optical Emission Spectroscopy (ICP-OES)

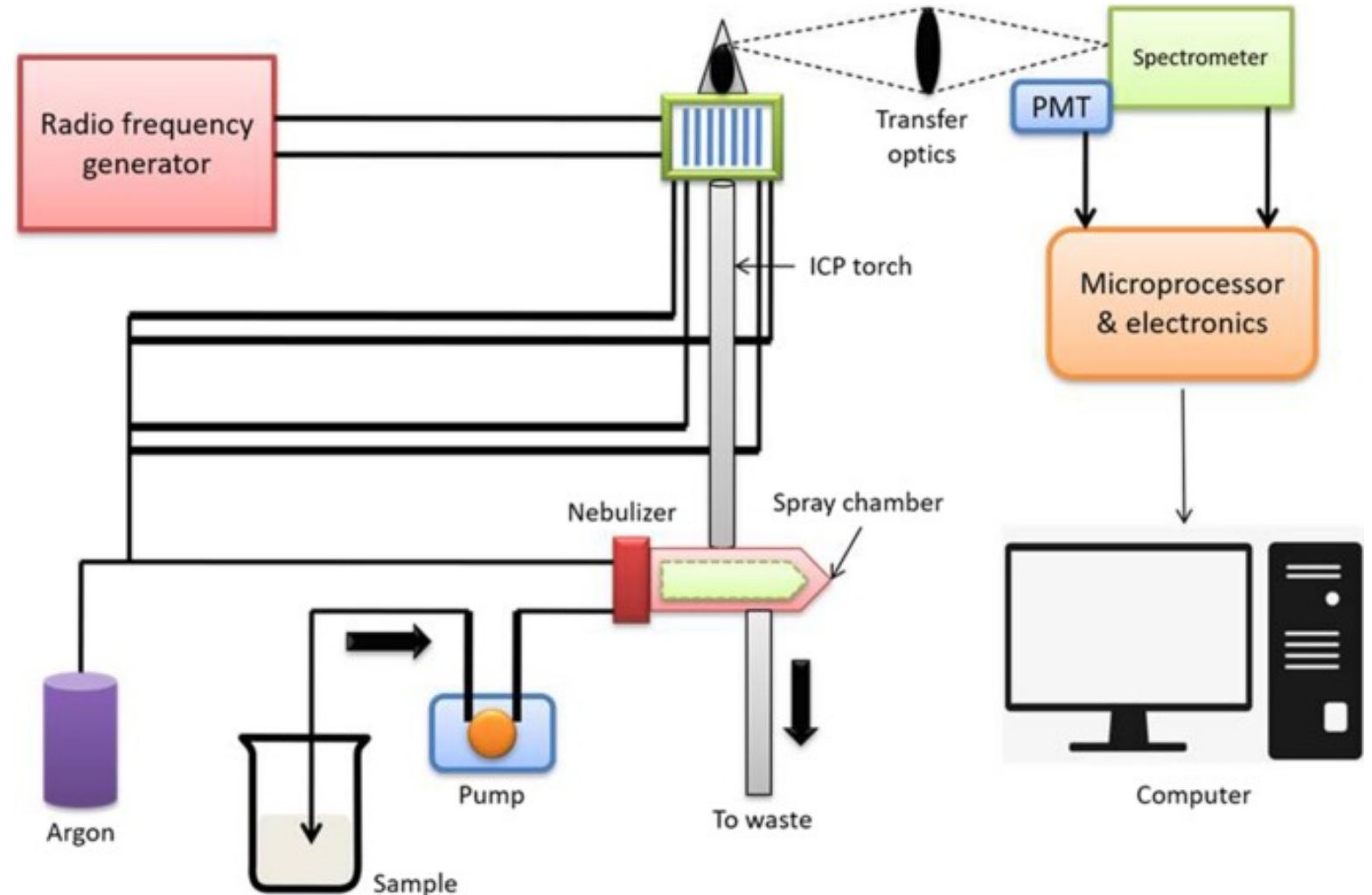

Electron microscopy can visualize metal collection in a cell

- Transmission Electron Microscopy (TEM)
 - send electron beam through a sample
 - generated image is shaded according to density
- TEM micrograph of root section from plant exposed to Cd for 14 days
 - Identified granules containing Cd in the cell wall of pericycle cells

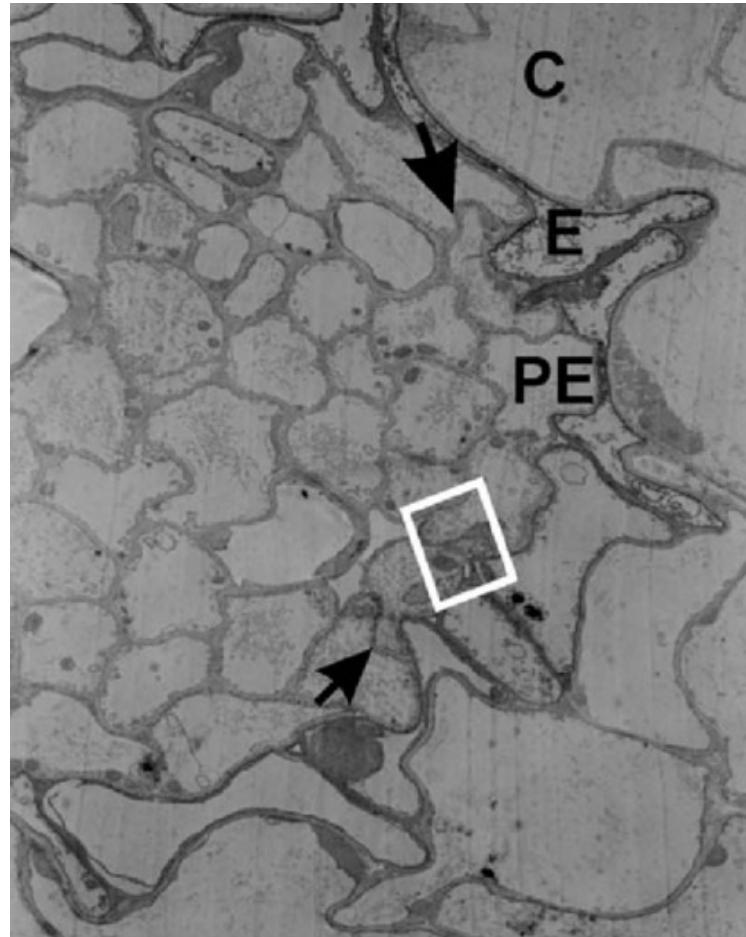

2000x magnification

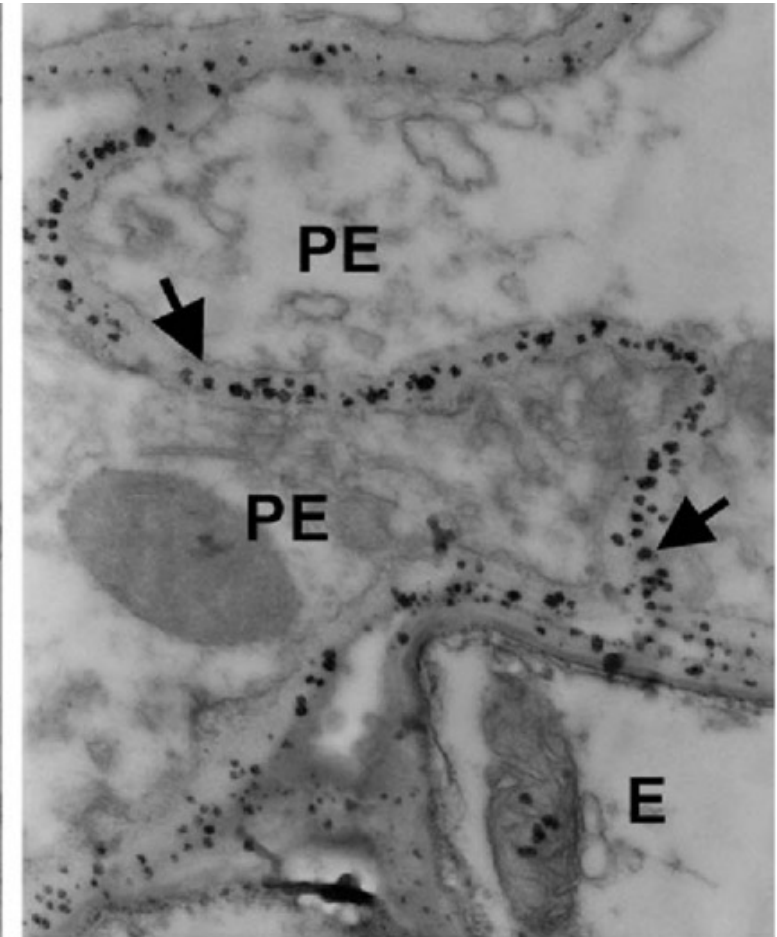

20,000x magnification

Radioactive metal isotopes can be utilized to monitor metal presence

- Incubate cells with radioactive isotope of metal
 - Rapid wash to remove any radioactive material not bound to or accumulated within the cell
 - Use gamma scintillation counter to convert radioactive decay to light to an electrical pulse
 - High sensitivity

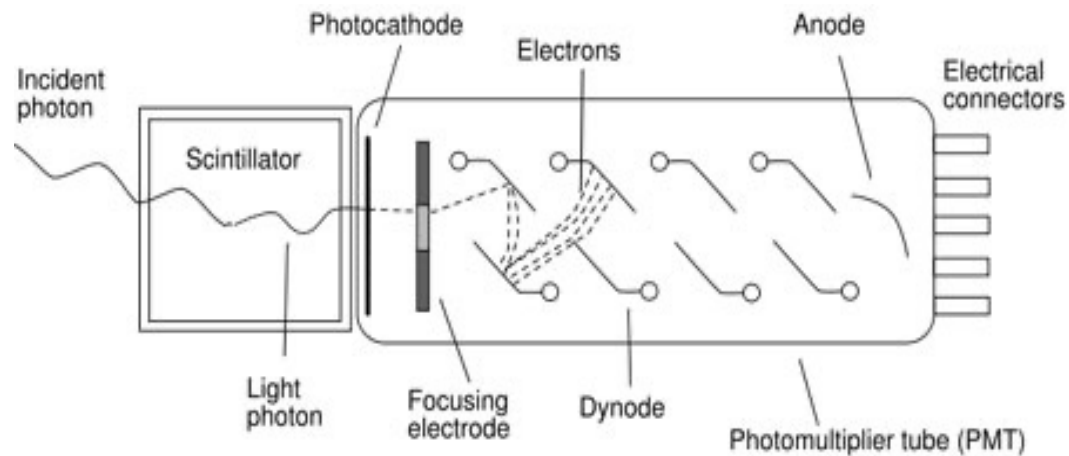

Stanford Scintillation Materials Group

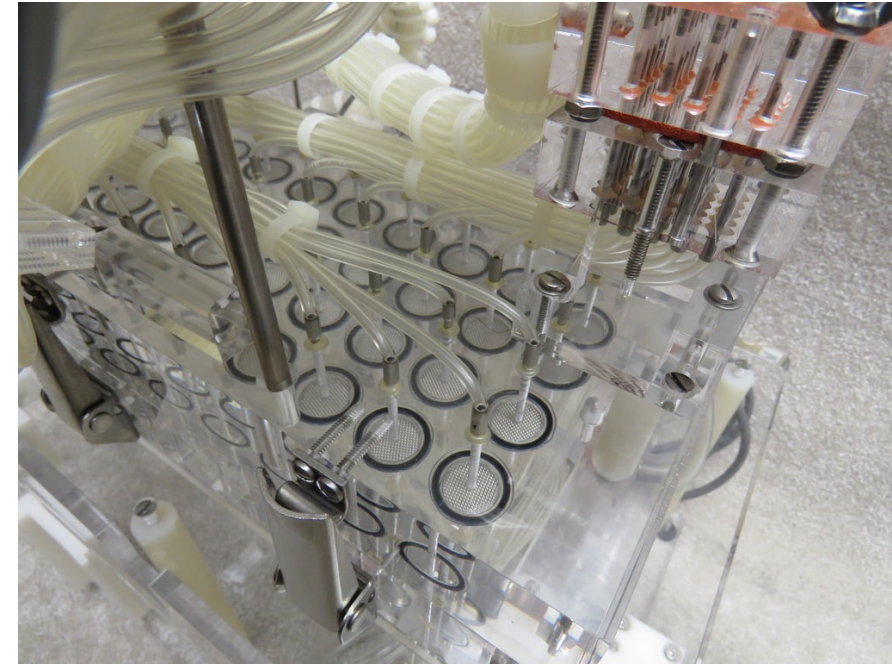

Brandel Cell Harvester

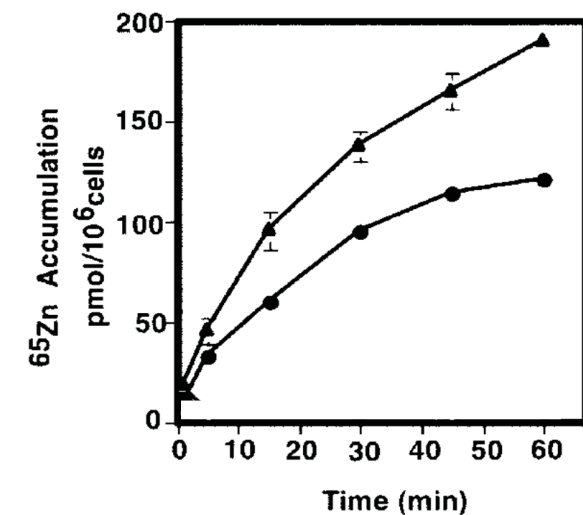

Gaither, 2001

Engineered sensors can be used to detect metal in a cell

- Förster Resonance Energy Transfer (FRET)

- Laser excited donor fluorophore
- Acceptor fluorophore emits fluorescent signal

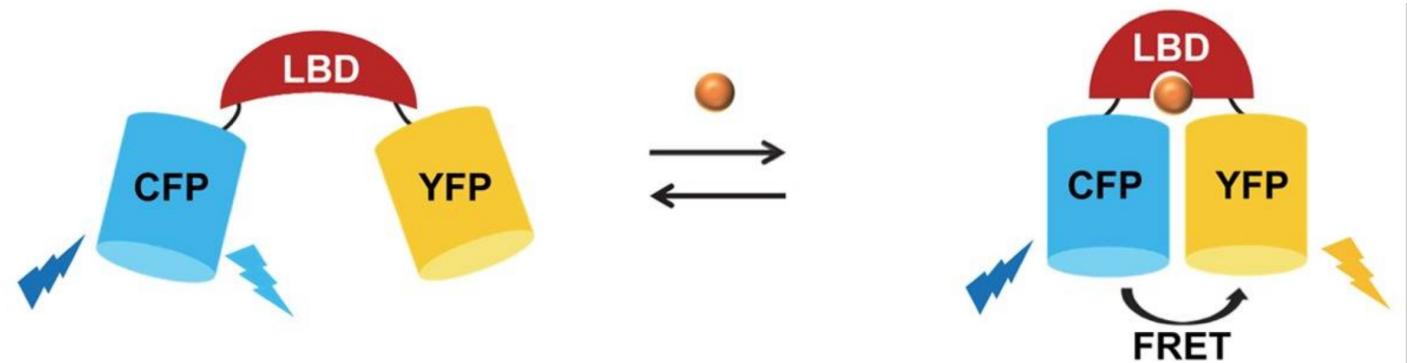

- Bioluminescence Resonance Energy Transfer (BRET)

- Bioluminescent luciferase excites the acceptor fluorophore

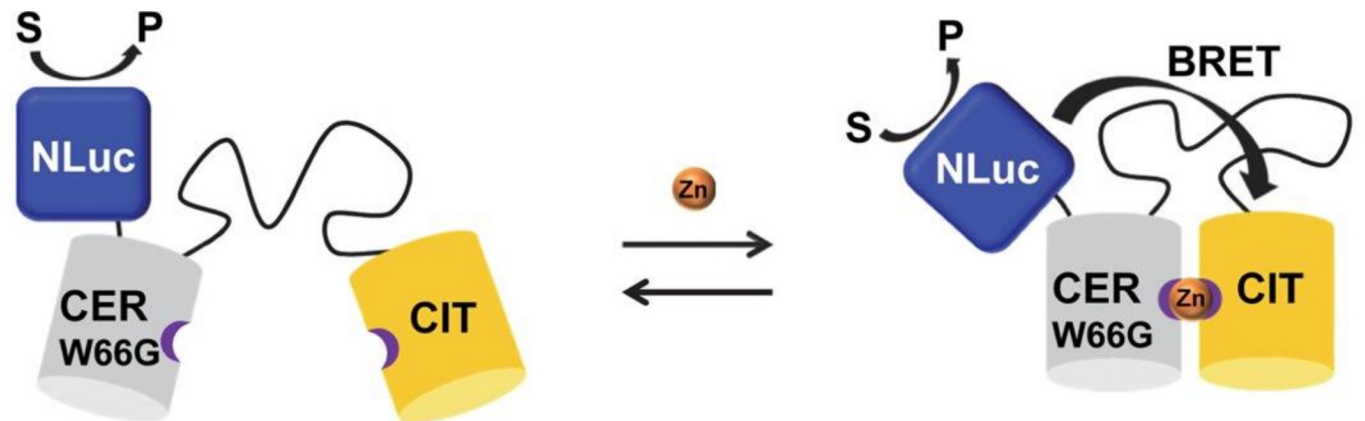

- Fluorescent probes

- small enough to cross a membrane and bind to intracellular metal
- not as sensitive as the sensors

Cell tolerance of metal accumulation

Different metrics can be used to assess cell viability

- Growth rate
- Membrane integrity
- Metabolic activity

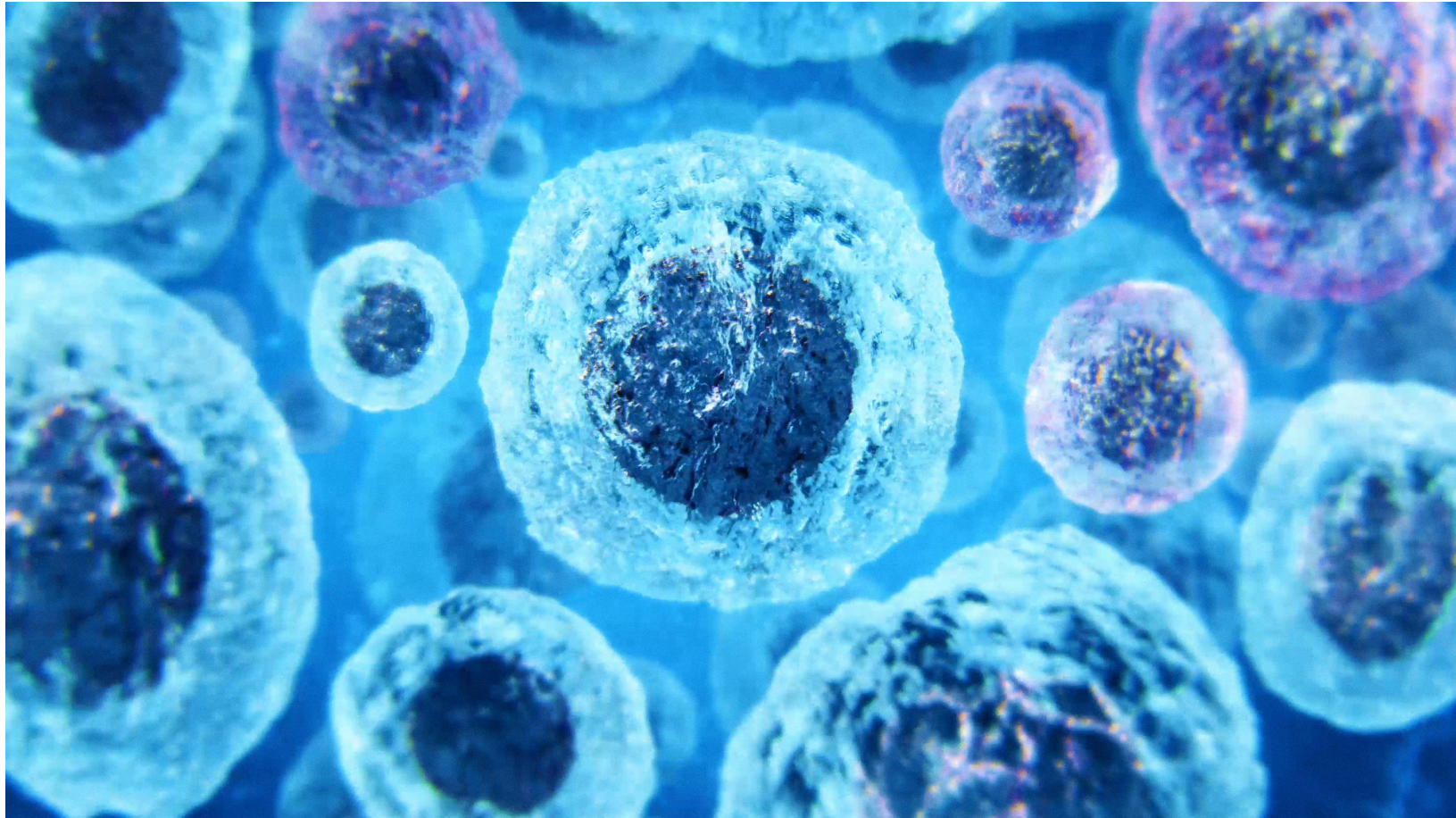

Spotting assay can be used to count colonies and compare growth under different conditions

- Commonly used to evaluate bacterial or yeast growth and survival
- Measure the density of cells within a single spot of defined size
 - Count colonies
 - Densitometry
- Identify common dilution that will allow for most accurate comparison across groups

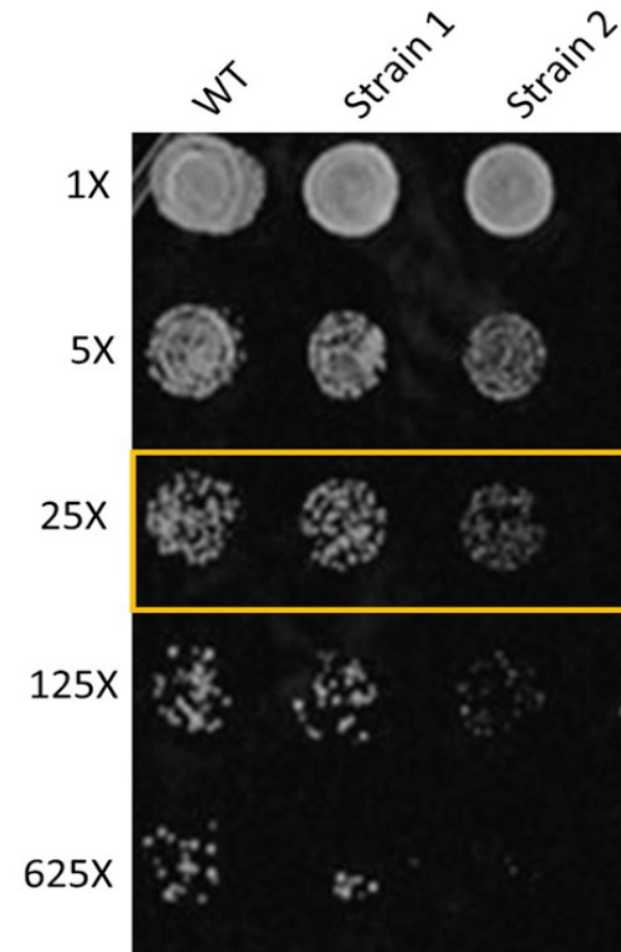

Petropavlovskiy. 2020

Vital dyes can be used to establish membrane integrity of cells

- Colormetric dyes
- **Neutral red**
 - weak cation dye
 - cross intact plasma membranes to concentrate in organelles like vacuoles and lysosomes
 - damage to those membranes prevents the incorporation of the dye because it can be washed out
 - Red= alive
- **Evans blue**
 - anionic dye
 - impermeable to membrane of living cells but able to accumulate in cells with compromised plasma membrane
 - Blue = dead
 - trypan blue is another example

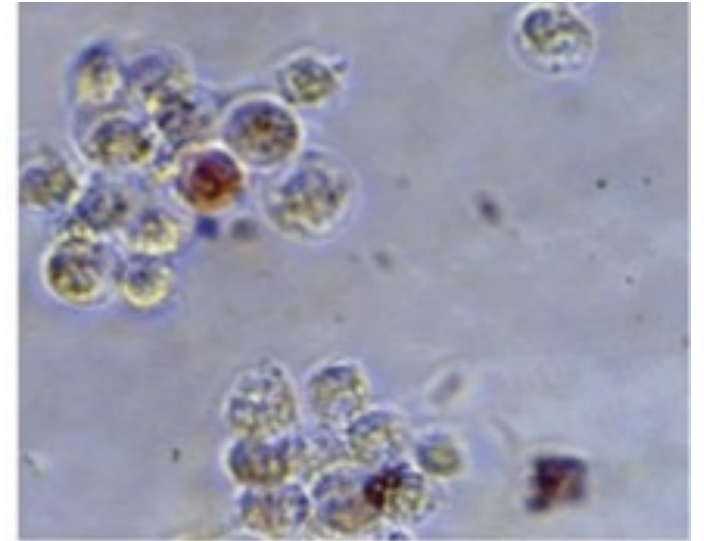

Neutral red



Evans blue dye

Nuclear fluorescent dyes can be used to indicate loss of membrane integrity

- SYTOX Green is a probe that cannot cross intact membranes
- One inside the nucleus, it binds to nucleic acids and fluoresces

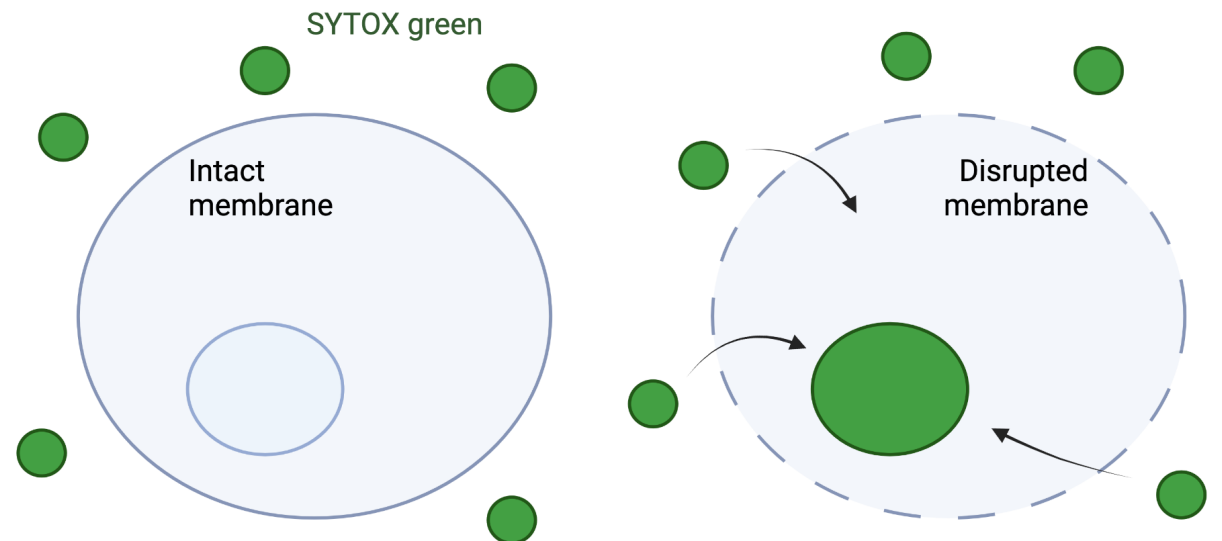
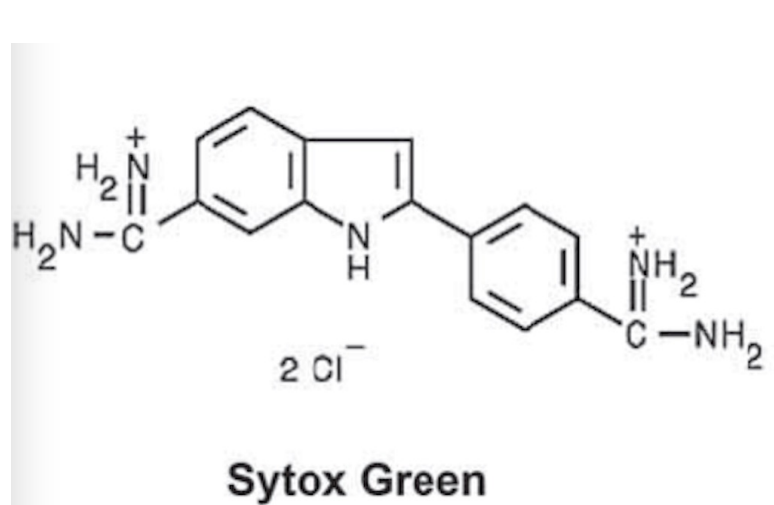

LIVE/DEAD assays can simultaneously mark both states of cells within a population

- SYTO 9 green-fluorescent nucleic acid stain
 - Can cross intact membranes and label all cells in a population
- Propidium iodide nucleic acid stain
 - Only enters cells with damaged membranes
 - Interacts with SYTO 9 to produce a red fluorescence
- Cells with intact membranes stain fluorescent green
- Cells with damaged membranes stain fluorescent red

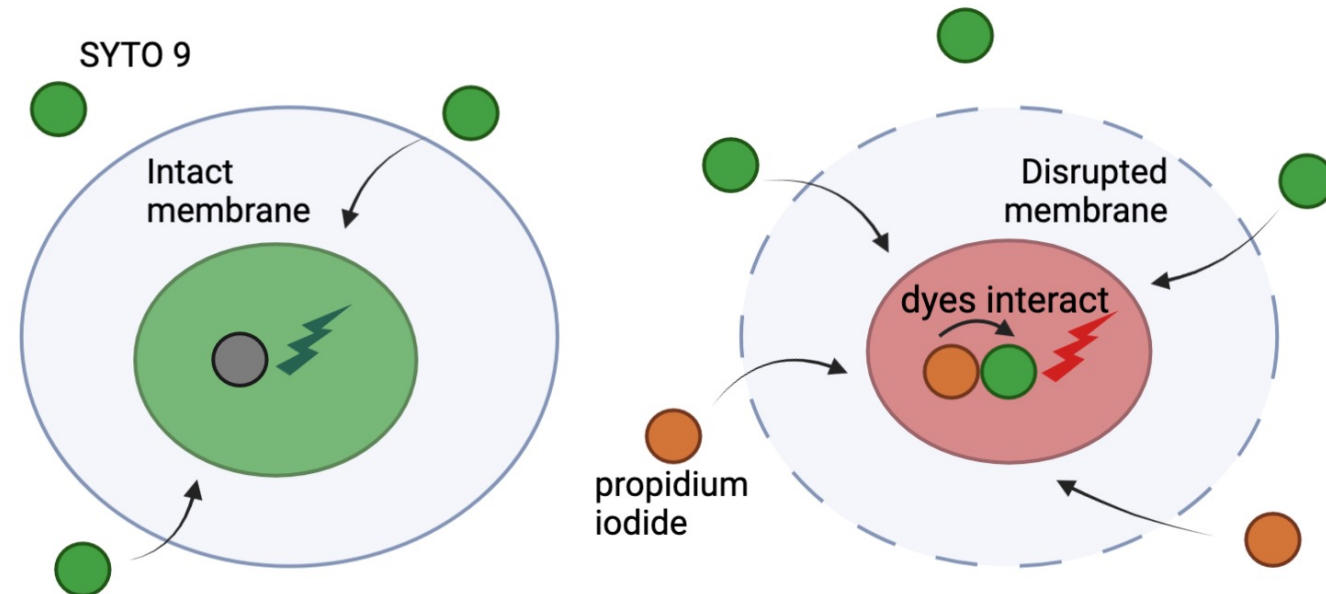
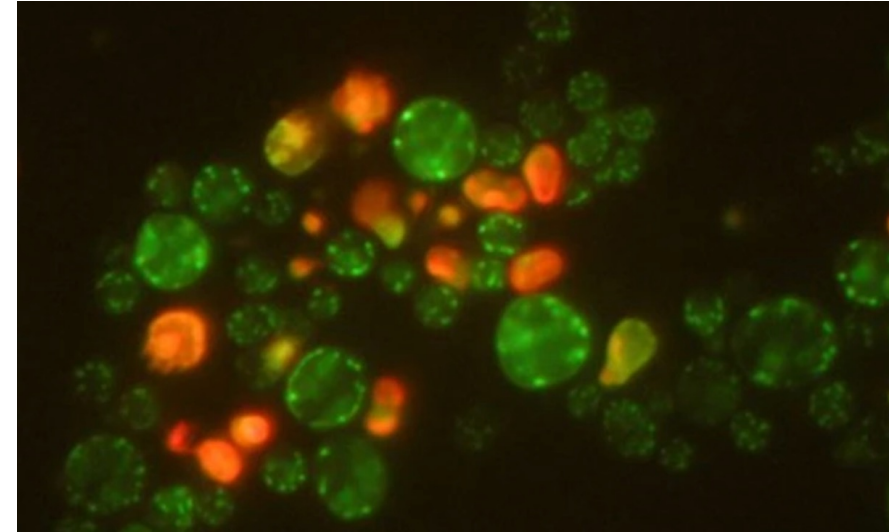

Reduction of tetrazolium salts creates color change proportional to metabolic activity

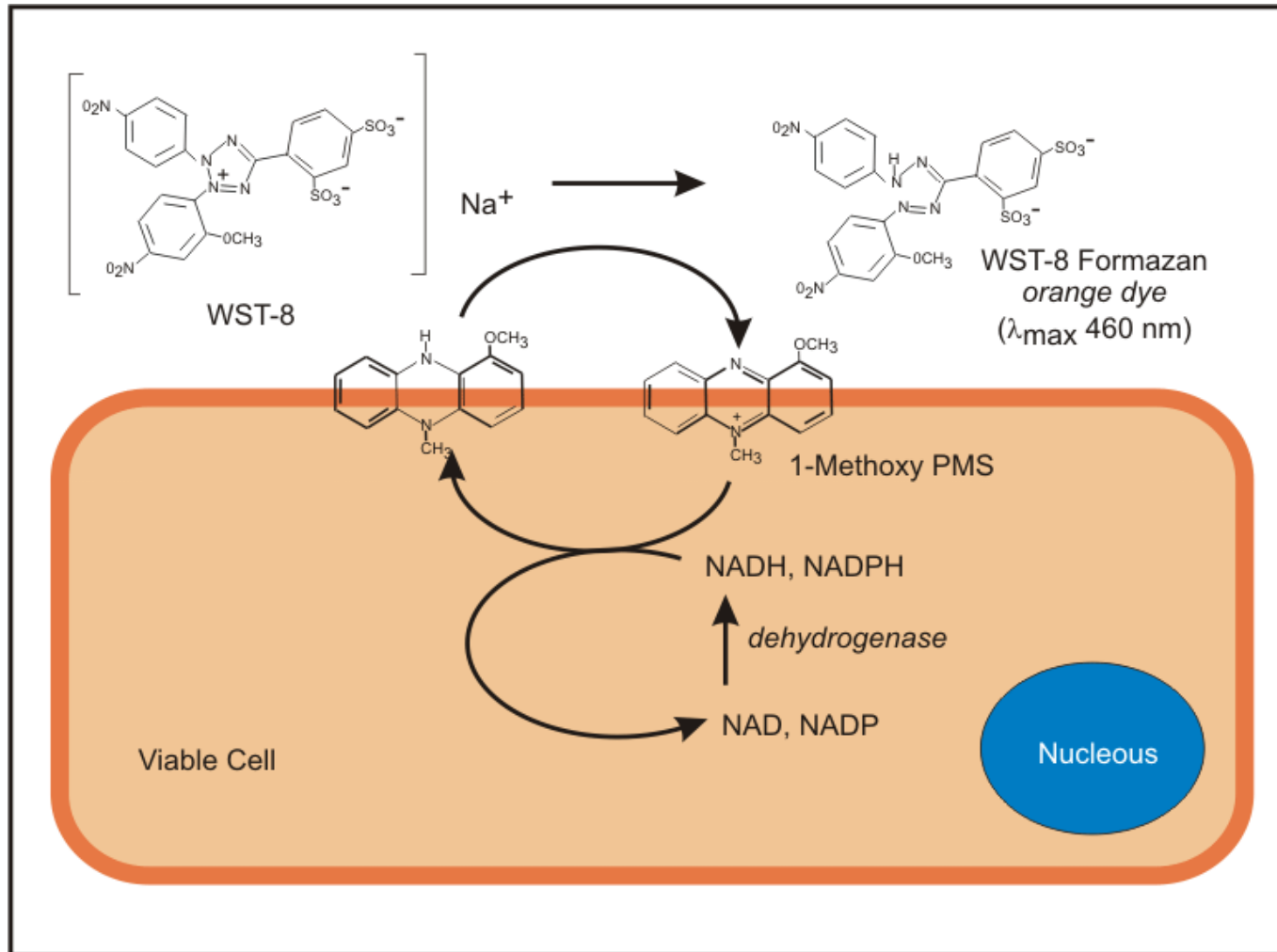

- Tetrazolium salts can be reduced into formazan as a byproduct of metabolic processes
- Color change is proportional to metabolic activity
- MTT = purple formazan precipitates
 - production kills cells
 - less sensitive
 - less expensive
- WST-8 = soluble orange formazan
 - cells survive assay
 - more sensitive
 - more expensive

ATP content can be used as a proxy for cellular physiology and metabolic activity

- Luciferase utilizes ATP to oxidize Luciferin to Oxyluciferin
 - Emits light as a result
- Luminescence is proportional to ATP and thus to cell metabolic activity
- Metabolic activity can change without resulting in cell death
 - In contrast to loss of membrane integrity

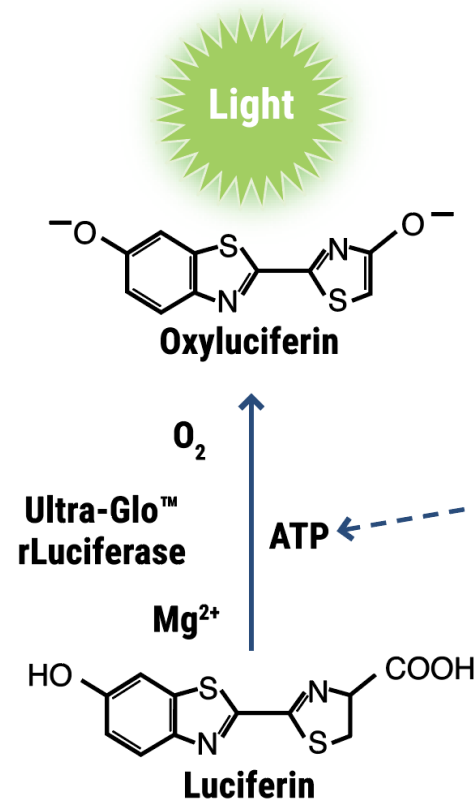

The cell is the source of ATP in the luciferase reaction, so the luminescence produced is proportional to the number of viable cells.

CellTiter-Glo® Assay is lytic.

VIABLE CELL

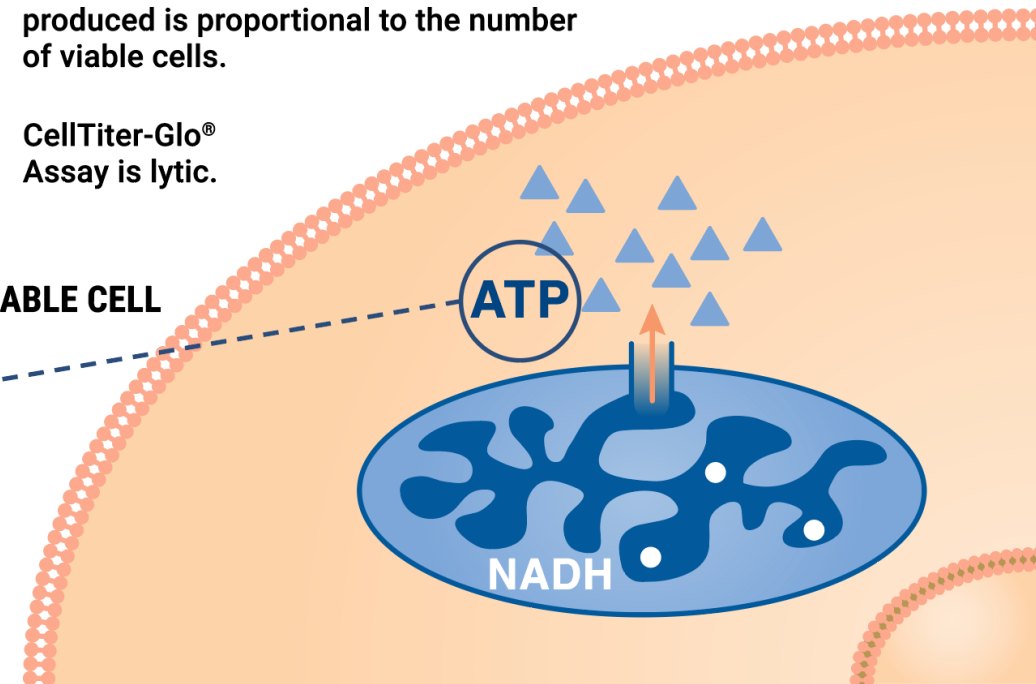

What are you doing in lab today?

- Experimental lull!
 - Biology moves slower than grand plans...
- Align sequencing to determine presence of mutations
- Prepare coverslips for the immunofluorescence experiment that begins after Spring break/ Journal article presentation week